

Réglette étanche slim LED

KEMBLA III 1489mm 50W 4000K 6500lm

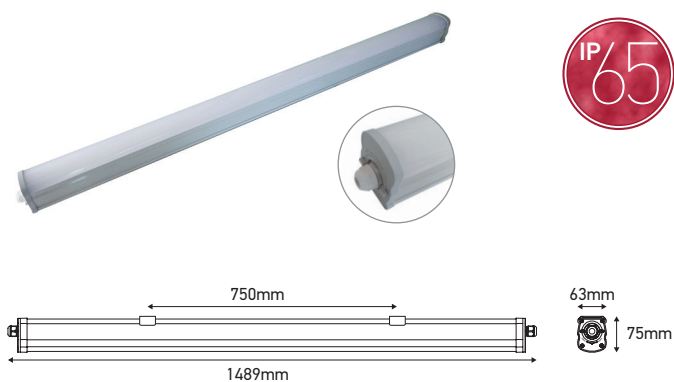
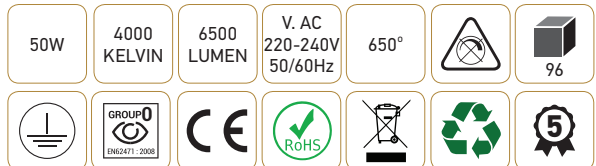

Ref: 168988

EAN	3125461689889
Puissance	50W
Température de couleur	4000K
Flux lumineux	6500lm
Driver	FIN FLPN-600370C-30 Entrée 220-240V 300mA 50/60Hz Sortie 120-160V 370mA Ta 25°C Tc 50°C
Angle de diffusion	120°
Température de fonctionnement	-25°C ~ 50°C
Nombre de LED	SAMSUNG 196pcs
Niveau de scintillement LED	Medium (20-40%)
Protection étanchéité	65
Durée de vie	54 000H
IRC	≥80
IK	08
PF	≥0.9
UGR	<26
Diffuseur	Opaline
Matériel	PC
Finition	Gris clair (RAL 7035)
Dimensions	1489 x 63 x 75mm

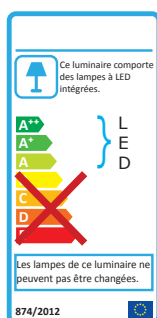
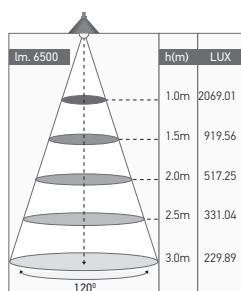

Notes

 47, rue des Tournelles, 75 003 Paris.

 En Courta-Rama 2 | 1163 Etoy.

 Neustrasse 26, D-54413 Grimburg.

 U13 Bentley Court, Finedon Road Ind. Est. Wellingborough,
Northamptonshire, NN8 4BQ.

 Girard Sudron Belgique SARL. Rue Van Eyck, 22
B1000 - Bruxelles, BELGIQUE

 Lighting Difusion Italia srl Via Savonarola, 217,
35137 Padova.